

# FUTEK MODEL FR1020

# MOUNTING KIT / INSTALLATION

Drawing Number: F2217-02

INCH [mm] | R.O.= Rated Output

WIRING CODE (WC1)

+Excitation	-Excitation	+Signal	-Signal
RED	BLACK	GREEN	WHITE

ITEM	NAME	MATERIAL	QTY
1	F1020-1	Aluminum	1
2	F1020-2	Aluminum	1
3	F1020-3	Aluminum	1
4	4-40X1/4	SHC Alloy	2

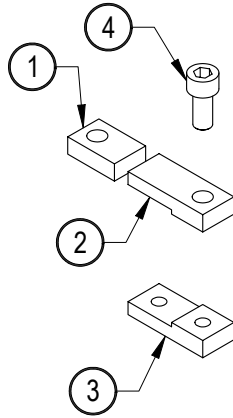

DWG. #	C	D
F1020-2	NONE	Ø0.120
F1020-3	#4-40	#4-40

F1020-1

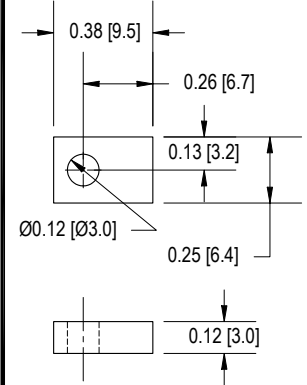
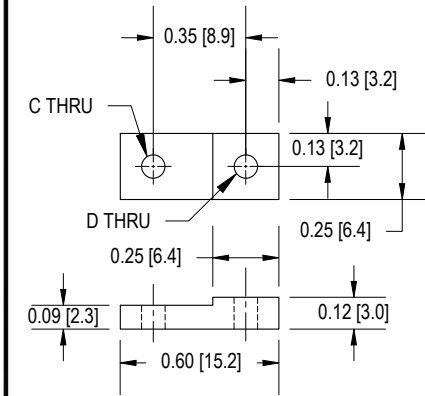

EXPLODED

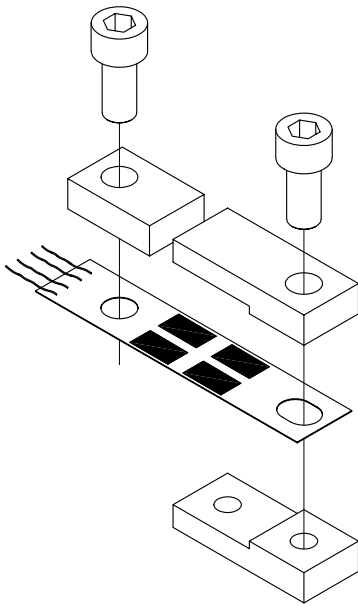

ASSEMBLED DIMENSIONS

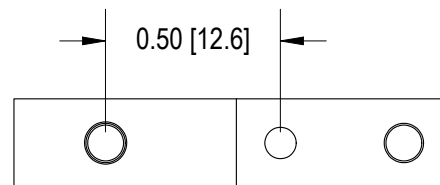
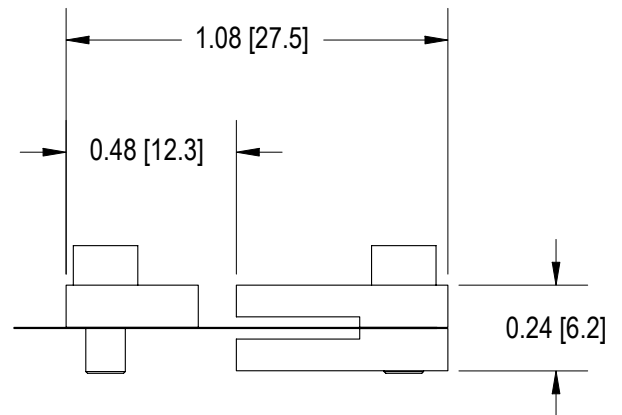
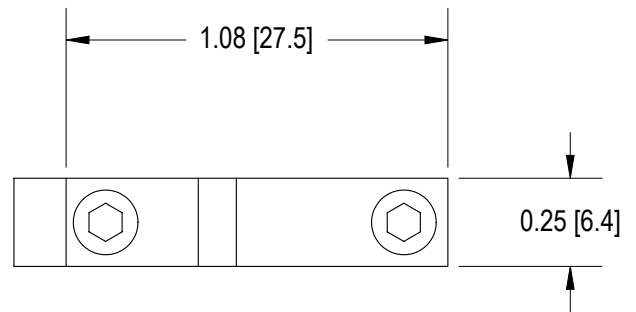

ASSEMBLED

