



FEATURES

- Fast response time
- Robust strain relief
- Compatible in load washer applications
- Offered in a variety of capacities and inner diameters

 Non-loading surface, do not contact

 Active End

 Fixed End

+ Output (compression)

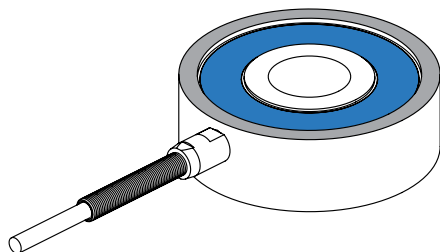
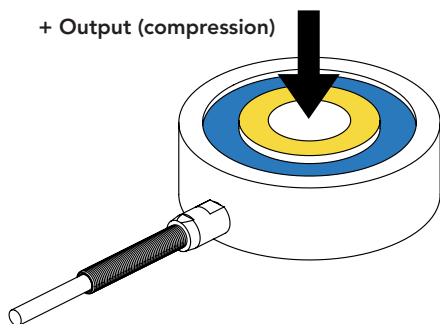

SPECIFICATIONS

PERFORMANCE

Nonlinearity	±0.5% of RO
Hysteresis	±0.5% of RO
Nonrepeatability	±0.5% of RO

ELECTRICAL

Rated Output (RO)	2 mV/V nom
Excitation (VDC or VAC)	18 max
Bridge Resistance	700 Ohm nom
Insulation Resistance	≥500 MOhm @ 50 VDC
Connection	#24 AWG, 4 conductor, braided shielded Teflon cable, 10 ft [3 m] long

Wiring/Connector Code WC1

MECHANICAL

Capacities	10000 lb [44480 N]
Weight (approximate)	8 oz [227 g]
Safe Overload	150% of RO
Deflection	0.002 in [0.05 mm] nom
Material	17-4 PH stainless-steel
IP Rating	IP64

TEMPERATURE

Operating Temperature	-60 to 200°F (-50 to 93°C)
Compensated Temperature	60 to 160°F (15 to 72°C)
Temperature Shift Zero	±0.005% of RO/°F (0.01% of RO/°C)
Temperature Shift Span	±0.005% of Load/°F (0.01% of Load/°C)

CALIBRATION

Calibration Test Excitation	10 VDC
Calibration (standard)	5-pt Compression
Shunt Calibration Value	100 kOhm

DIMENSIONS inches [mm]

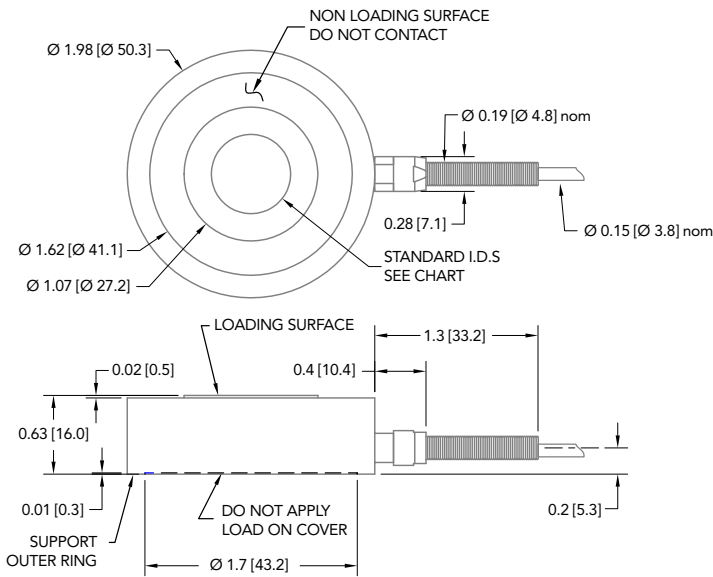

WIRING CODE (WC1 WITH SHIELD)

RED	+ EXCITATION
BLACK	- EXCITATION
GREEN	+ SIGNAL
WHITE	- SIGNAL
SHIELD	FLOATING

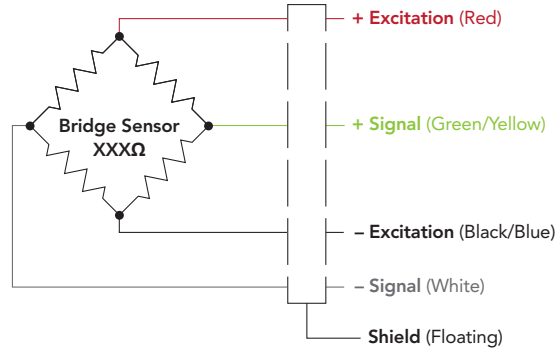

INNER DIAMETER

ID	Dimension ^{+0.01} _{-0.00} [^{+0.25} _{-0.00}]
1/8	0.134 [3.40]
3/16	0.197 [5.01]
1/4	0.259 [6.58]
5/16	0.322 [8.18]
3/8*	0.384 [9.75]
7/16	0.447 [11.35]
1/2*	0.509 [12.93]
9/16	0.572 [14.53]
5/8*	0.634 [16.10]

*Commonly stocked capacities and inner diameters

Note: While torquing bolts, high tension forces will occur during installation, which could result in overloading the sensor. FUTEK recommends connecting the sensor to a system in order to monitor the applied forces. FUTEK is not liable or responsible for the mishandling of the sensor during installation.

Drawing Number: FI1426

FUTEK reserves the right to modify its design and specifications without notice. Please visit www.futek.com/salesterms for complete terms and conditions.

10 Thomas, Irvine, CA 92618 USA

Tel: (949) 465-0900

Fax: (949) 465-0905

www.futek.com



U.S. Manufacturer